

Tapsold el a képek nevét!

Ügyelj a „jajgatóhangok” (j) és az „éneklőhangok” (l) ejtésére!

Színezz ki annyi karikát, ahányat tapsoltál!

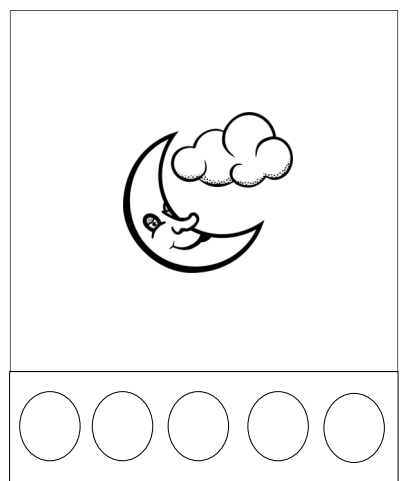
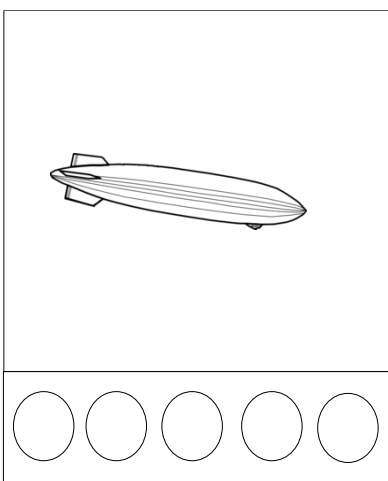
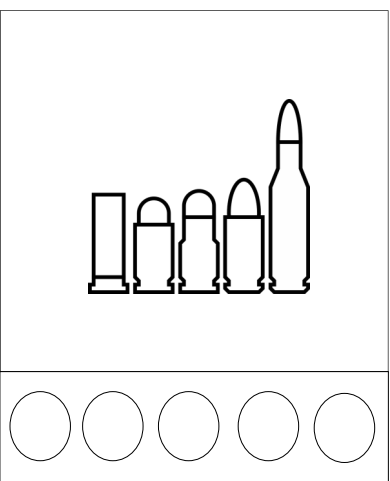
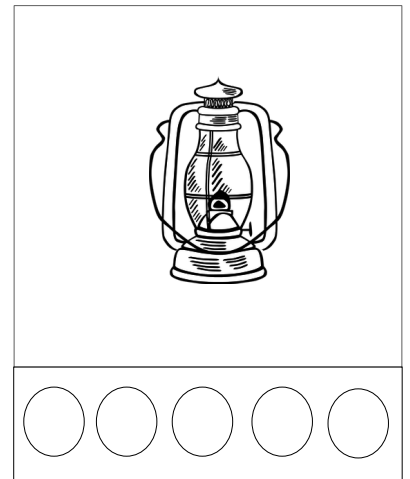
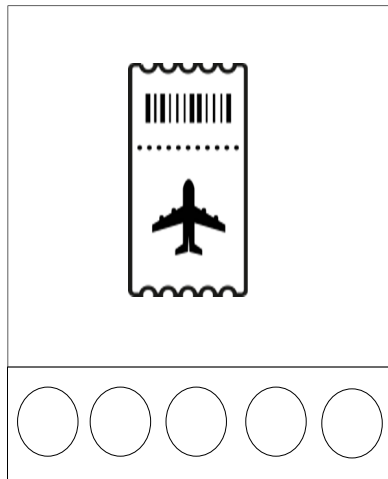
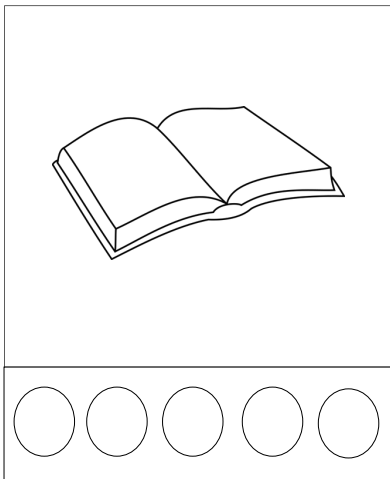
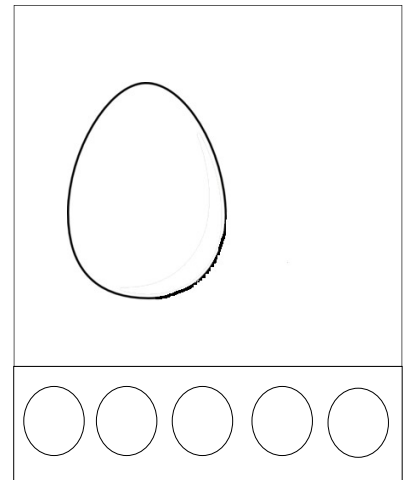
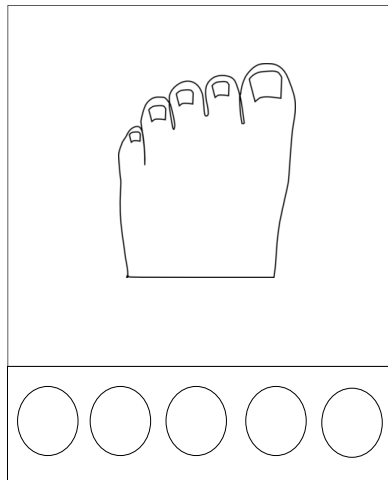
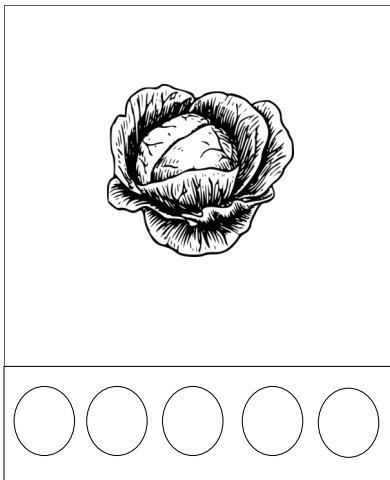

Mondd el milyen képek nevét tapsoltad el!

fejes saláta, lábujj, lúdtojás, jutalomkönyv, repülőjegy,

olajlámpa, pisztolytöltény, léghajó, éjjel

Karikázd be azokat az képeket, amelyek megegyeznek a felső képpel!

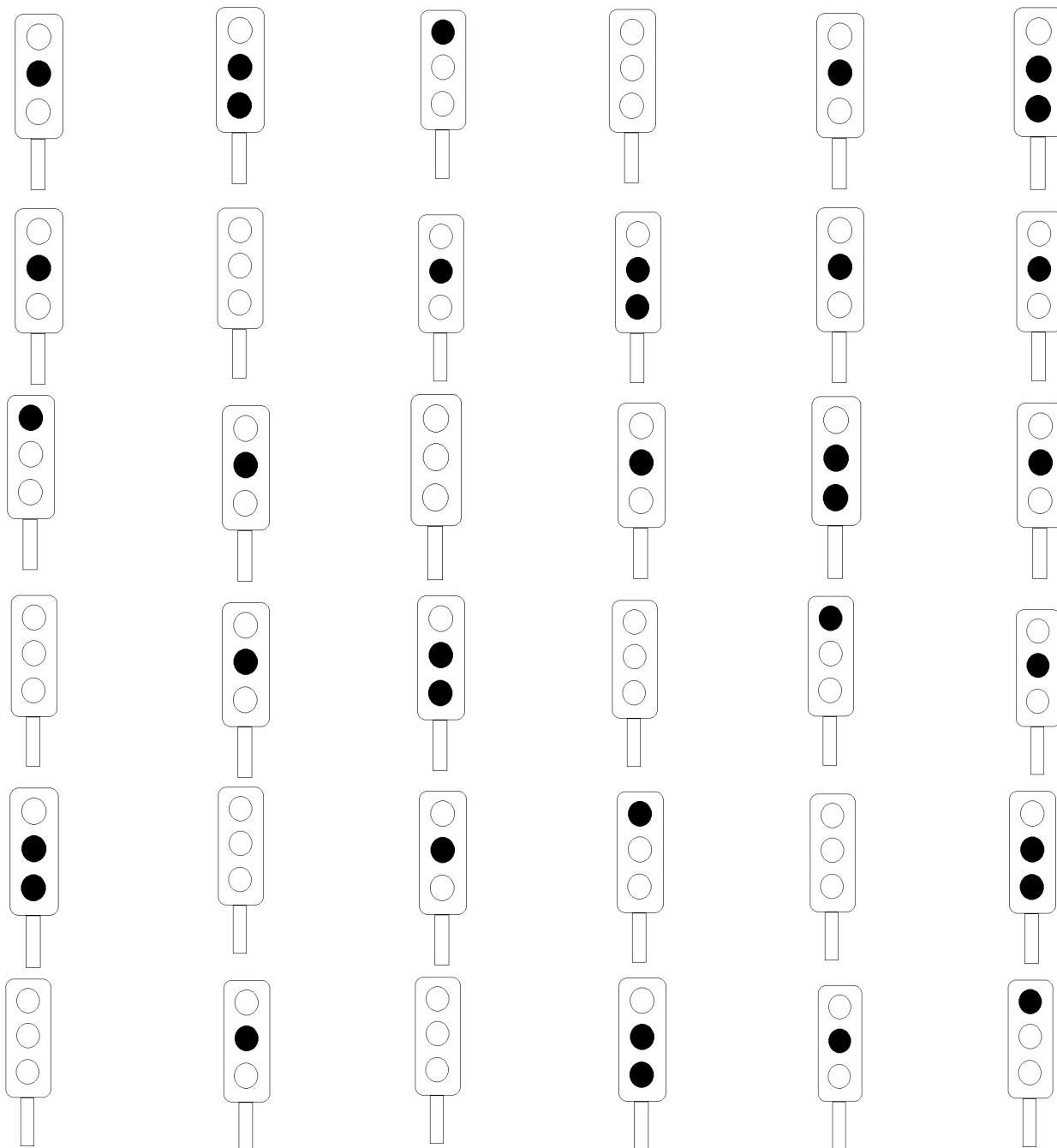
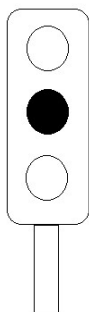

Számold meg hány olyan jelzőlámpát találtál, mint a felső!

Keressd meg a párját és kösd össze őket!

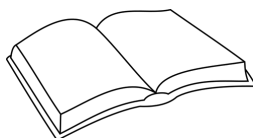
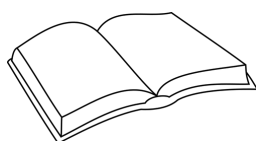

Sorold fel milyen képek párjait kerested meg!

éjjel, gomolyfelhő, jutalomkönyv, olajlámpás, halpikkely, juhászlegény, golyóstoll,